

## Instrukcja montażu

Installation instructions  
Instructions de montage  
Montageanleitung

IP20

230 V  
50 Hz

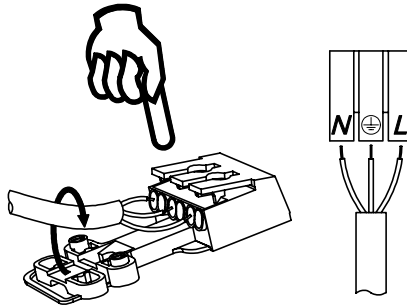
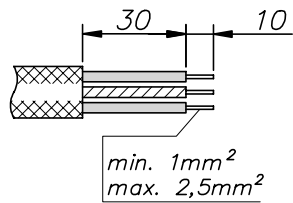
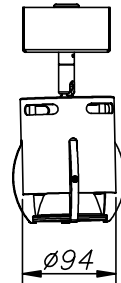
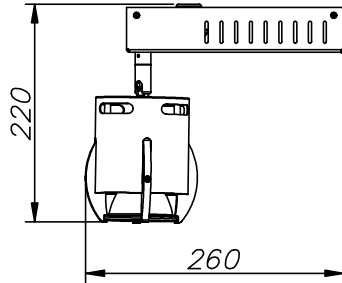
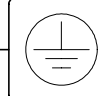

PL - Rozłączyć zapięcie przed wymianą lampy.  
UK - Disconnect the unit before changing the lamp.  
F - Debrancher l'appareil avant de changer la lampe.  
D - Von dem Auswechseln der Lampe die Leuchte von der Netzspannung trennen.



①

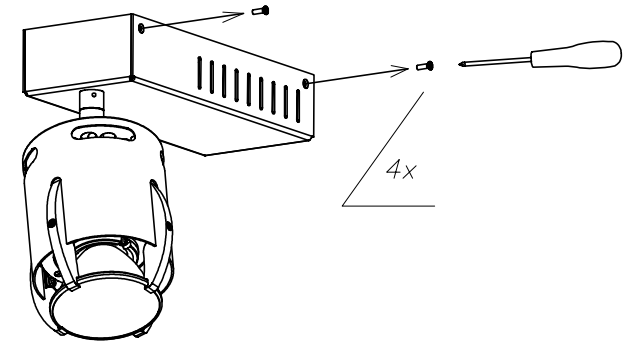

②

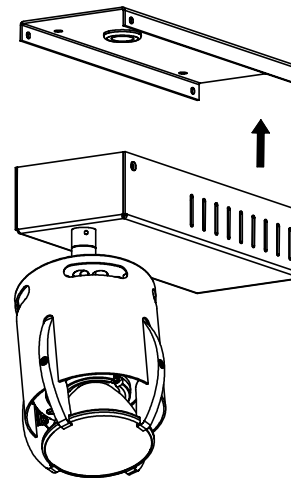

③

