

UNO ECO LED MINI

Instrukcja montażu

Instructions de montage
Montageanleitung

ИНСТРУКЦИЯ МОНТАЖА

IP20

230 V
50 Hz

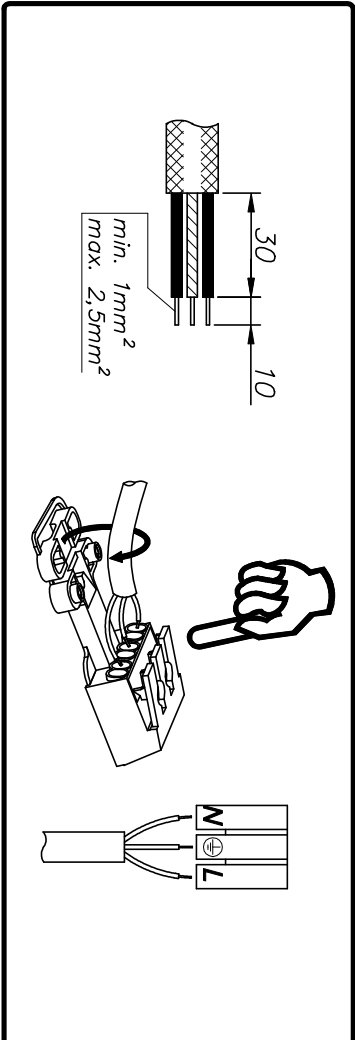
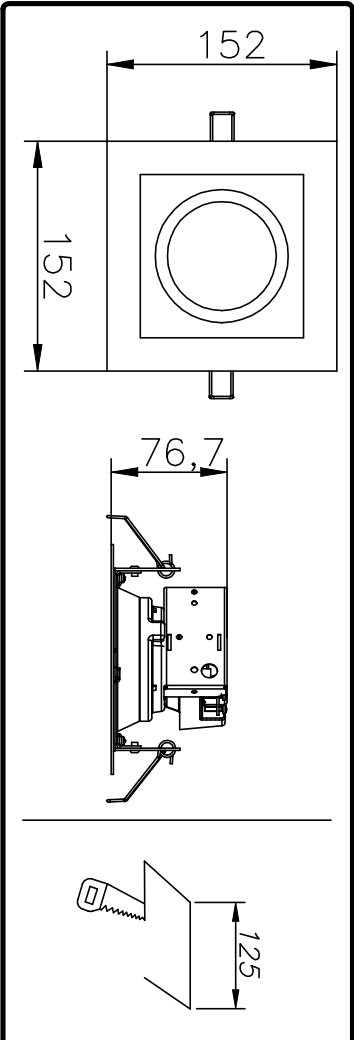
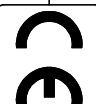
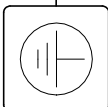

- PL – Wyłączyć zasilanie przed wymianą lampy;
- UK – Disconnect the unit before changing the lamp;
- F – Débrancher l'appareil avant de changer la lampe;
- D – Von den Auswechsellin der Lampe die Leuchte von der Netzspannung trennen.

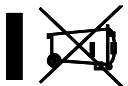

IMPERIAL sp. z o.o. s. k. a.
ul. Kobiłzewska 85, 78-200 Białogard
tel. +48 94 312 78 20, tel./fax. +48 94 312 78 69
email: office@imperial.pl
NIP: 672-000-62-93

imperial®

1

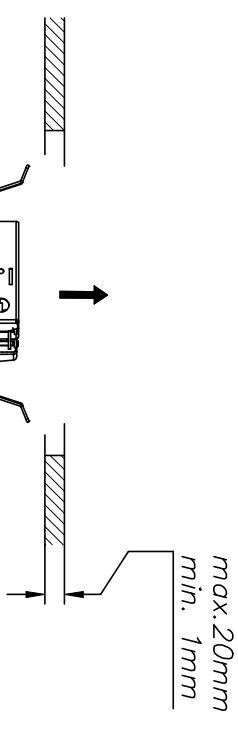

2

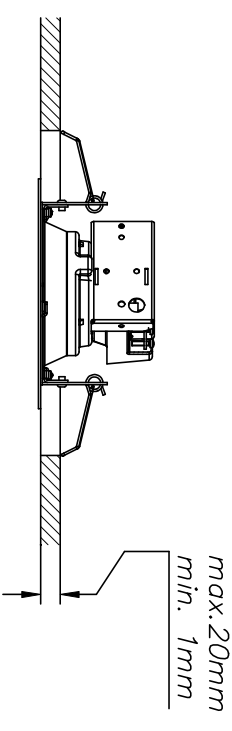

IMPERIAL sp. z o.o. s. k. a.
ul. Kobiłzewska 85, 78-200 Białogard
tel. +48 94 312 78 20, tel./fax. +48 94 312 78 69
email: office@imperial.pl
NIP: 672-000-62-93

imperial®